

Q-Series

Innovative, easy to use and quick cable tie system

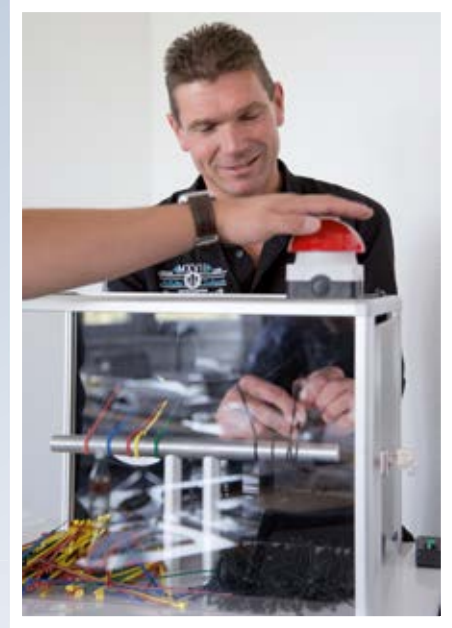

Become the fastest with us:
More than a 25% time saving with Q-Series!



One Step to the Web!



Cable Ties with open head

Q-ties

The Q-tie is a unique and innovative product for bundling and fixing cables for a wide range of applications. It is available in various colours and materials. The innovative design of the open head tie provides an easy insertion even under difficult circumstances.

A wide range of products is available:

- Polyamide 6.6 (PA66), black, natural and in various colours
- Polyamide 6.6 weather-resistant (PA66W), only black
- Polyamide 6.6 heat stabilised (PA66HS), black and natural

See page 6.



Cable Ties With Fixing Elements

2-Piece Fixing Ties for edges

The unique features and associated benefits of two products – Q-ties and EdgeClips – are combined in a 2-piece fixing tie that reduces installation time and improves manufacturing, assembly and / or maintenance processes.

See page 11.



Self adhesive/screw fixing Cable Tie Mounts QM(A)

Q-mounts

The mounting bases Q-mounts are an ideal complement for Q-ties. Design and functionality of the mounting bases match perfectly to provide an optimised working process. Different types and sizes are available:

- 4-way mounts (QM)
- 2-way mounts (CTQM)
- Screwable/Self adhesive mounts
- Polyamide 6.6 (PA66), black, natural

See page 12.



Identification tags for marking cable bundles

Q-tags

Besides fastening and fixing, the identification of cables is another important aspect of cable management. The Q-tag cable markers can be perfectly used with Q-ties. The tags offer different options for marking:

- manual with marker pen
- with adhesive label

See page 14.





Cable Ties and Fixings

Cable Ties Inside Serrated

Q-ties

Innovative – Effective – Safe!

The new Q-tie has not only innovative, but also has a revolutionary new design. The open head of the cable tie enables a simple and quick installation. Simply insert the ergonomically bent tail into the open side of the head and tighten the cable tie.

With Q-ties you can save time and money!

Easy Application for every Situation!

Q-tie provides the perfect solution for applications in difficult working conditions. It is ideal for use when working with gloves is necessary or for blind applications with a limited view of the work allowing for a quick and simple installation.

Features for quick and easy application:

- Large curved tail with easy-grip ribs
- Open head with easily detectable slot

This saves time and trouble!

Integrated Pre-locking Functionality!

Due to several simultaneous working processes, it is not always possible to install all cables and conduits in one single step.

Using standard cable ties means either removing the cable tie of the first installation or applying additional cable ties. The integrated pre-locking function offers both a temporary and final cable fastening solution.

This saves material and time!



The head design makes the difference.



Even under difficult circumstances the Q-tie cable tie is very fast and easy to apply.



Without additional effort only Q-ties can be used for temporary and final cable bundling.



Application video: Q-Series

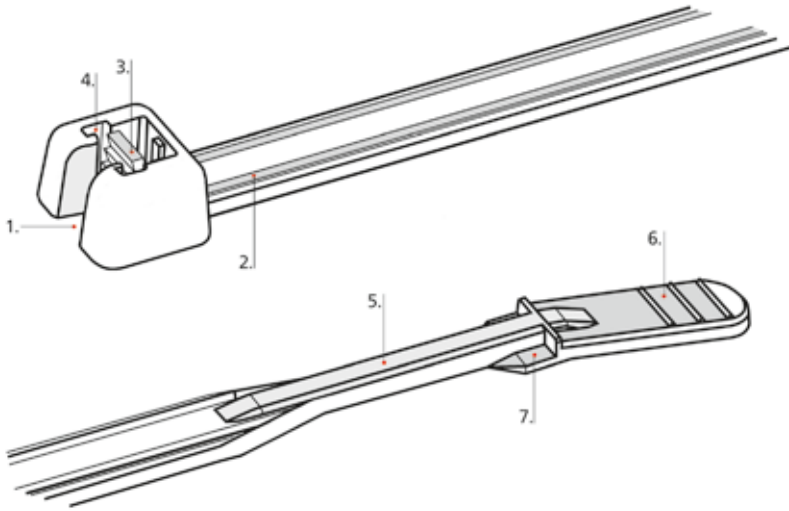
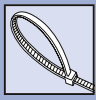

Features of Q-ties:

1. Open lock head for quick and easy insertion.
2. Two rails on the strap ensure perfect guidance for the tracks in the head.
3. The locking device interacts safely with the serration of the cable tie.
4. The tracks prevent a deformation of the head under load.
5. The thin part of the cable tie can be simply placed into the open lock head.
6. The large ribbed tail allows a safe and ergonomic installation.
7. Integrated pre-locking feature (starts with type Q30).

Application Method:



1. Insert the thin part of the cable tie into the open lock head.

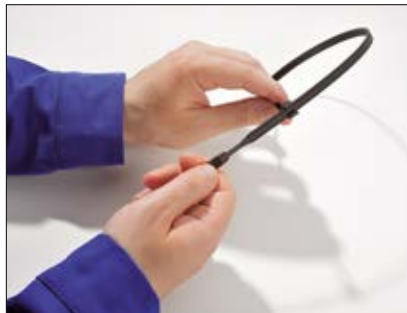

2. Pull the tie through the head until the bundle is fixed.
3. Cut off the remaining part of the tie with an application tool.

Pre-locking Function of the Q-tie:



1. Insert tail into the open head and push the tail partly into the head.

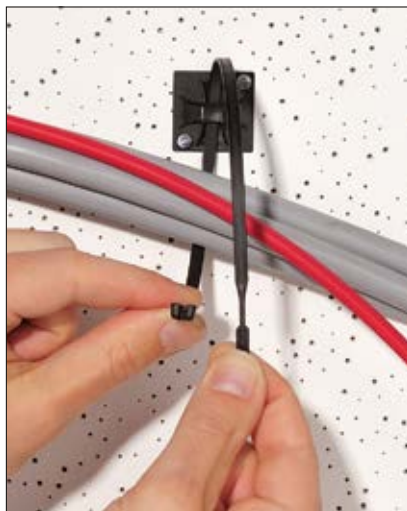

2. To release the tie push the tail slightly out of the head.



3. When the installation is complete, the Q-tie can be tightened and cut off – either manually or with an application tool.



Cable Ties and Fixings

Cable Ties Inside Serrated

Cable Ties with open head Polyamide 6.6 standard

Q-Series in PA66 natural and black

Q-Series cable ties for bundling and securing cables, pipes and hoses. These innovative and effective cable ties enable a simple and quick installation, even in difficult applications.

Features and Benefits

- Open lock head for quick and easy insertion
- Integrated pre-locking function
- More than 25% faster to apply than a standard cable tie
- Inside serration for a strong hold around bundles
- Easy application either manually or with a processing tool



Q-tie cable ties: choose from a wide product range in different sizes.

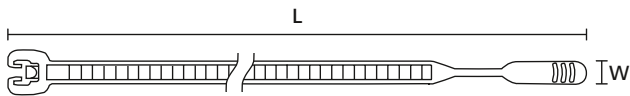

Q-Series

TYPE	Width (W)	Length (L)	Bundle Ø max.	N	Material	Colour	Pack Cont.	Tools	Article-No.
Q18R	2.6	105.0	24.0	80	PA66	Black (BK)	100 pcs.	2;4-6	109-00030
	2.6	105.0	24.0	80	PA66	Natural (NA)	100 pcs.	2;4-6	109-00001
Q18I	2.6	155.0	40.0	80	PA66	Black (BK)	100 pcs.	2;4-6	109-00033
	2.6	155.0	40.0	80	PA66	Natural (NA)	100 pcs.	2;4-6	109-00004
Q18L	2.6	195.0	50.0	80	PA66	Black (BK)	100 pcs.	2;4-6	109-00036
	2.6	195.0	50.0	80	PA66	Natural (NA)	100 pcs.	2;4-6	109-00007
Q30R	3.6	160.0	38.0	130	PA66	Black (BK)	100 pcs.	2;4-6	109-00039
	3.6	160.0	38.0	130	PA66	Natural (NA)	100 pcs.	2;4-6	109-00010
Q30L	3.6	200.0	50.0	130	PA66	Black (BK)	100 pcs.	2;4-6	109-00041
	3.6	200.0	50.0	130	PA66	Natural (NA)	100 pcs.	2;4-6	109-00012
Q30LR	3.6	250.0	65.0	130	PA66	Black (BK)	100 pcs.	2;4-6	109-00043
	3.6	250.0	65.0	130	PA66	Natural (NA)	100 pcs.	2;4-6	109-00014
Q50R	4.7	210.0	50.0	220	PA66	Black (BK)	100 pcs.	2-10	109-00047
	4.7	210.0	50.0	220	PA66	Natural (NA)	100 pcs.	2-10	109-00018
Q50I	4.7	290.0	75.0	220	PA66	Black (BK)	100 pcs.	2-10	109-00049
	4.7	290.0	75.0	220	PA66	Natural (NA)	100 pcs.	2-10	109-00020
Q50L	4.7	410.0	110.0	220	PA66	Black (BK)	100 pcs.	2-10	109-00051
	4.7	410.0	110.0	220	PA66	Natural (NA)	100 pcs.	2-10	109-00022
Q120I	7.7	300.0	70.0	530	PA66	Black (BK)	100 pcs.	3;9-12	109-00053
	7.7	300.0	70.0	530	PA66	Natural (NA)	100 pcs.	3;9-12	109-00024
Q120R	7.7	420.0	110.0	530	PA66	Black (BK)	100 pcs.	3;9-12	109-00055
	7.7	420.0	110.0	530	PA66	Natural (NA)	100 pcs.	3;9-12	109-00026
Q120M	7.7	520.0	130.0	530	PA66	Black (BK)	100 pcs.	3;9-12	109-00057
	7.7	520.0	130.0	530	PA66	Natural (NA)	100 pcs.	3;9-12	109-00028

All dimensions in mm. Subject to technical changes.

Minimum Order Quantity (MOQ) may differ from package content. Other packaging options may also be available.

Recommended Tools

2	3	4	5	6	7	8	9	10	11	12
MK20	MK21	MK3SP	MK3PNSP2	EVO7	MK7HT	MK7P	MK6	MK9	MK9HT	MK9P

For detailed information on Application Tooling please refer to our Main Catalogue or the Internet.



Please note! Not all products listed on this page may have this approval.



Cable Ties with open head for outdoor use (UV-resistant)

Q-Series in PA66W black

Q-Series cable ties for bundling and securing cables, pipes and hoses. These innovative and effective cable ties enable a simple and quick installation, even in difficult applications.

Features and Benefits

- Weather-resistant black cable ties available in a wide range of sizes
- Open lock head for quick and easy insertion
- Integrated pre-locking function
- More than 25% faster to apply than a standard cable tie
- Inside serration for a strong hold around bundles
- Easy application either manually or with a processing tool
- UV-resistant



Q-tie cable ties: choose from a wide product range in different sizes.



Material specification
please see page 15.

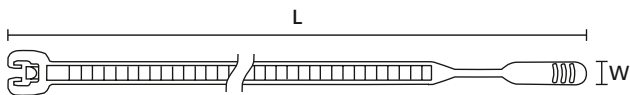

Q-Series



Application tools
please see page 15.

TYPE	Width (W)	Length (L)	Bundle Ø max.	N	Material	Colour	Pack Cont.	Tools	Article-No.
Q18R	2.6	105.0	24.0	80	PA66W	Black (BK)	100 pcs.	2;4-6	109-00059
Q18I	2.6	155.0	40.0	80	PA66W	Black (BK)	100 pcs.	2;4-6	109-00062
Q18L	2.6	195.0	50.0	80	PA66W	Black (BK)	100 pcs.	2;4-6	109-00065
Q30R	3.6	160.0	38.0	130	PA66W	Black (BK)	100 pcs.	2;4-6	109-00068
Q30L	3.6	200.0	50.0	130	PA66W	Black (BK)	100 pcs.	2;4-6	109-00070
Q30LR	3.6	250.0	65.0	130	PA66W	Black (BK)	100 pcs.	2;4-6	109-00072
Q50R	4.7	210.0	50.0	220	PA66W	Black (BK)	100 pcs.	2-10	109-00076
Q50I	4.7	290.0	75.0	220	PA66W	Black (BK)	100 pcs.	2-10	109-00078
Q50L	4.7	410.0	110.0	220	PA66W	Black (BK)	100 pcs.	2-10	109-00080
Q120I	7.7	300.0	70.0	530	PA66W	Black (BK)	100 pcs.	3;9-12	109-00082
Q120R	7.7	420.0	110.0	530	PA66W	Black (BK)	100 pcs.	3;9-12	109-00084
Q120M	7.7	520.0	130.0	530	PA66W	Black (BK)	100 pcs.	3;9-12	109-00086

All dimensions in mm. Subject to technical changes.
Minimum Order Quantity (MOQ) may differ from package content. Other packaging options may also be available.

Recommended Tools										
2	3	4	5	6	7	8	9	10	11	12
MK20	MK21	MK3SP	MK3PNSP2	EVO7	MK7HT	MK7P	MK6	MK9	MK9HT	MK9P

For detailed information on Application Tooling please refer to our Main Catalogue or the Internet.



Cable Ties and Fixings

Cable Ties Inside Serrated

Cable Ties with open head for temperatures up to +105 °C (heat stabilised)

Q-Series in PA66HS natural and black

Q-Series cable ties for bundling and securing cables, pipes and hoses. These innovative and effective cable ties enable a simple and quick installation, even in difficult applications.

Features and Benefits

- Heat stabilised cable ties available in a wide range of sizes
- Open lock head for quick and easy insertion
- Integrated pre-locking function
- More than 25% faster to apply than a standard cable tie
- Inside serration for a strong hold around bundles
- Easy application either manually or with a processing tool
- Higher temperature resistance up to +105 °C



Q-tie cable ties: choose from a wide product range in different sizes.

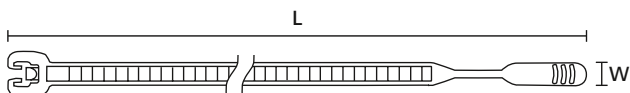

Q-Series

TYPE	Width (W)	Length (L)	Bundle Ø max.		Material	Colour	Pack Cont.	Tools	Article-No.
Q18R	2.6	105.0	24.0	80	PA66HS	Black (BK)	100 pcs.	2;4-6	109-00088
	2.6	105.0	24.0	80	PA66HS	Natural (NA)	100 pcs.	2;4-6	109-00117
Q18I	2.6	155.0	40.0	80	PA66HS	Black (BK)	100 pcs.	2;4-6	109-00091
	2.6	155.0	40.0	80	PA66HS	Natural (NA)	100 pcs.	2;4-6	109-00120
Q18L	2.6	195.0	50.0	80	PA66HS	Black (BK)	100 pcs.	2;4-6	109-00094
	2.6	195.0	50.0	80	PA66HS	Natural (NA)	100 pcs.	2;4-6	109-00123
Q30R	3.6	160.0	38.0	130	PA66HS	Black (BK)	100 pcs.	2;4-6	109-00097
	3.6	160.0	38.0	130	PA66HS	Natural (NA)	100 pcs.	2;4-6	109-00126
Q30L	3.6	200.0	50.0	130	PA66HS	Black (BK)	100 pcs.	2;4-6	109-00099
	3.6	200.0	50.0	130	PA66HS	Natural (NA)	100 pcs.	2;4-6	109-00128
Q30LR	3.6	250.0	65.0	130	PA66HS	Black (BK)	100 pcs.	2;4-6	109-00101
	3.6	250.0	65.0	130	PA66HS	Natural (NA)	100 pcs.	2;4-6	109-00130
Q50R	4.7	210.0	50.0	220	PA66HS	Black (BK)	100 pcs.	2-10	109-00105
	4.7	210.0	50.0	220	PA66HS	Natural (NA)	100 pcs.	2-10	109-00134
Q50I	4.7	290.0	75.0	220	PA66HS	Black (BK)	100 pcs.	2-10	109-00107
	4.7	290.0	75.0	220	PA66HS	Natural (NA)	100 pcs.	2-10	109-00136
Q50L	4.7	410.0	110.0	220	PA66HS	Black (BK)	100 pcs.	2-10	109-00109
	4.7	410.0	110.0	220	PA66HS	Natural (NA)	100 pcs.	2-10	109-00138
Q120I	7.7	300.0	70.0	530	PA66HS	Black (BK)	100 pcs.	3;9-12	109-00111
	7.7	300.0	70.0	530	PA66HS	Natural (NA)	100 pcs.	3;9-12	109-00140
Q120R	7.7	420.0	110.0	530	PA66HS	Black (BK)	100 pcs.	3;9-12	109-00113
	7.7	420.0	110.0	530	PA66HS	Natural (NA)	100 pcs.	3;9-12	109-00142
Q120M	7.7	520.0	130.0	530	PA66HS	Black (BK)	100 pcs.	3;9-12	109-00115
	7.7	520.0	130.0	530	PA66HS	Natural (NA)	100 pcs.	3;9-12	109-00144

All dimensions in mm. Subject to technical changes.

Minimum Order Quantity (MOQ) may differ from package content. Other packaging options may also be available.

Recommended Tools										
2	3	4	5	6	7	8	9	10	11	12
MK20	MK21	MK3SP	MK3PNSP2	EVO7	MK7HT	MK7P	MK6	MK9	MK9HT	MK9P

For detailed information on Application Tooling please refer to our Main Catalogue or the Internet.

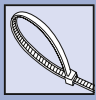

Cable Ties with open head Polyamide 6.6 standard

Q-Series in PA66 coloured

Q-Series cable ties for bundling and securing cables, pipes and hoses. These innovative and effective cable ties enable a simple and quick installation, even in difficult applications.

Features and Benefits

- Coloured cable ties available in a wide range of sizes
- Open lock head for quick and easy insertion
- Integrated pre-locking function
- More than 25% faster to apply than a standard cable tie
- Inside serration for a strong hold around bundles
- Easy application either manually or with a processing tool

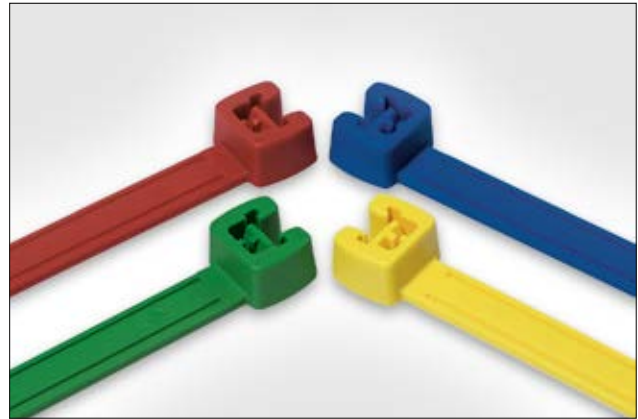

Q-ties in different colours are ideal for marking and bundling in one step.



Application video: Q-Series



Material specification
please see page 15.



Application tools
please see page 15.

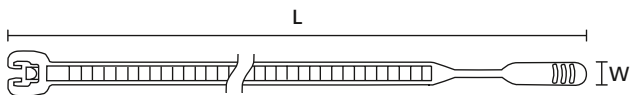

Q-Series

TYPE	Width (W)	Length (L)	Bundle Ø max.	N	Material	Colour	Pack Cont.	Tools	Article-No.
Q18R	2.6	105.0	24.0	80	PA66	Blue (BU)	100 pcs.	2;4-6	109-00147
	2.6	105.0	24.0	80	PA66	Green (GN)	100 pcs.	2;4-6	109-00148
	2.6	105.0	24.0	80	PA66	Red (RD)	100 pcs.	2;4-6	109-00149
	2.6	105.0	24.0	80	PA66	Yellow (YE)	100 pcs.	2;4-6	109-00150
Q18I	2.6	155.0	40.0	80	PA66	Blue (BU)	100 pcs.	2;4-6	109-00152
	2.6	155.0	40.0	80	PA66	Green (GN)	100 pcs.	2;4-6	109-00153
	2.6	155.0	40.0	80	PA66	Red (RD)	100 pcs.	2;4-6	109-00154
	2.6	155.0	40.0	80	PA66	Yellow (YE)	100 pcs.	2;4-6	109-00155
Q18L	2.6	195.0	50.0	80	PA66	Blue (BU)	100 pcs.	2;4-6	109-00157
	2.6	195.0	50.0	80	PA66	Green (GN)	100 pcs.	2;4-6	109-00158
	2.6	195.0	50.0	80	PA66	Red (RD)	100 pcs.	2;4-6	109-00159
	2.6	195.0	50.0	80	PA66	Yellow (YE)	100 pcs.	2;4-6	109-00160

All dimensions in mm. Subject to technical changes.
Minimum Order Quantity (MOQ) may differ from package content. Other packaging options may also be available.

Recommended Tools										
2	3	4	5	6	7	8	9	10	11	12
MK20	MK21	MK3SP	MK3PNP2	EVO7	MK7HT	MK7P	MK6	MK9	MK9HT	MK9P

For detailed information on Application Tooling please refer to our Main Catalogue or the Internet.



Please note! Not all products listed on this page may have this approval.



Cable Ties and Fixings

Cable Ties Inside Serrated

Cable Ties with open head Polyamide 6.6 standard

Q-Series in PA66 coloured

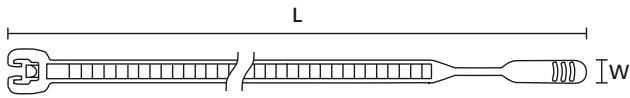

Q-Series



Material specification please see page 15.

TYPE	Width (W)	Length (L)	Bundle Ø max.	N	Material	Colour	Pack Cont.	Tools	Article-No.
Q30R	3.6	160.0	38.0	130	PA66	Blue (BU)	100 pcs.	2;4-6	109-00162
	3.6	160.0	38.0	130	PA66	Green (GN)	100 pcs.	2;4-6	109-00163
	3.6	160.0	38.0	130	PA66	Red (RD)	100 pcs.	2;4-6	109-00164
	3.6	160.0	38.0	130	PA66	Yellow (YE)	100 pcs.	2;4-6	109-00165
Q30L	3.6	200.0	50.0	130	PA66	Blue (BU)	100 pcs.	2;4-6	109-00167
	3.6	200.0	50.0	130	PA66	Green (GN)	100 pcs.	2;4-6	109-00168
	3.6	200.0	50.0	130	PA66	Red (RD)	100 pcs.	2;4-6	109-00169
	3.6	200.0	50.0	130	PA66	Yellow (YE)	100 pcs.	2;4-6	109-00170
Q30LR	3.6	250.0	65.0	130	PA66	Blue (BU)	100 pcs.	2;4-6	109-00172
	3.6	250.0	65.0	130	PA66	Green (GN)	100 pcs.	2;4-6	109-00173
	3.6	250.0	65.0	130	PA66	Red (RD)	100 pcs.	2;4-6	109-00174
	3.6	250.0	65.0	130	PA66	Yellow (YE)	100 pcs.	2;4-6	109-00175
Q50R	4.7	210.0	50.0	220	PA66	Blue (BU)	100 pcs.	2-10	109-00182
	4.7	210.0	50.0	220	PA66	Green (GN)	100 pcs.	2-10	109-00183
	4.7	210.0	50.0	220	PA66	Red (RD)	100 pcs.	2-10	109-00184
	4.7	210.0	50.0	220	PA66	Yellow (YE)	100 pcs.	2-10	109-00185
Q50I	4.7	290.0	75.0	220	PA66	Blue (BU)	100 pcs.	2-10	109-00187
	4.7	290.0	75.0	220	PA66	Green (GN)	100 pcs.	2-10	109-00188
	4.7	290.0	75.0	220	PA66	Red (RD)	100 pcs.	2-10	109-00189
	4.7	290.0	75.0	220	PA66	Yellow (YE)	100 pcs.	2-10	109-00190
Q50L	4.7	410.0	110.0	220	PA66	Blue (BU)	100 pcs.	2-10	109-00192
	4.7	410.0	110.0	220	PA66	Green (GN)	100 pcs.	2-10	109-00193
	4.7	410.0	110.0	220	PA66	Red (RD)	100 pcs.	2-10	109-00194
	4.7	410.0	110.0	220	PA66	Yellow (YE)	100 pcs.	2-10	109-00195
Q120I	7.7	300.0	70.0	530	PA66	Blue (BU)	100 pcs.	3;9-12	109-00197
	7.7	300.0	70.0	530	PA66	Green (GN)	100 pcs.	3;9-12	109-00198
	7.7	300.0	70.0	530	PA66	Red (RD)	100 pcs.	3;9-12	109-00199
	7.7	300.0	70.0	530	PA66	Yellow (YE)	100 pcs.	3;9-12	109-00200
Q120R	7.7	420.0	110.0	530	PA66	Blue (BU)	100 pcs.	3;9-12	109-00202
	7.7	420.0	110.0	530	PA66	Green (GN)	100 pcs.	3;9-12	109-00203
	7.7	420.0	110.0	530	PA66	Red (RD)	100 pcs.	3;9-12	109-00204
	7.7	420.0	110.0	530	PA66	Yellow (YE)	100 pcs.	3;9-12	109-00205
Q120M	7.7	520.0	130.0	530	PA66	Blue (BU)	100 pcs.	3;9-12	109-00207
	7.7	520.0	130.0	530	PA66	Green (GN)	100 pcs.	3;9-12	109-00208
	7.7	520.0	130.0	530	PA66	Red (RD)	100 pcs.	3;9-12	109-00209
	7.7	520.0	130.0	530	PA66	Yellow (YE)	100 pcs.	3;9-12	109-00210

All dimensions in mm. Subject to technical changes.
Minimum Order Quantity (MOQ) may differ from package content. Other packaging options may also be available.



Please note! Not all products listed on this page may have this approval.



2-Piece Fixing Ties for Edges, 1.0–3.0 mm, Side Fixing

These cable ties and EdgeClip assemblies are ideal for use where holes are not acceptable or where due to temperature problems adhesives will fail. These assemblies are widely used for fixing and bundling cables, pipes and hoses within the automotive industry, harness making, panel building and electrical industry.

Features and Benefits

- Pre-assembled 2-piece fixing tie with EdgeClip and Q-tie
- A perfect complement within our Q-Series range
- Unique and innovative cable tie with open-head design
- Time saving solution due to quick and simple installation
- Q-tie saves more than 25 % of usual working time
- Cable tie head can be moved after bundling
- For edges of 1–3 mm

 **Application tools**
please see page 15.

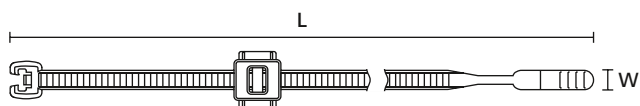

Q50REC4A



Q50REC5A, Q-tie with EdgeClip 1–3 mm Side Fixing.

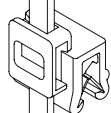
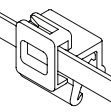

Q50REC4A, Q-tie with EdgeClip 1–3 mm Top Fixing.

TYPE	Drawing	Width (W)	Length (L)	Bundle Ø max.		Material Cable Tie	Material Foot Part	Colour	Tools	Article-No.
Q50REC5A		4.7	210.0	45.0	220	PA66W	PA66W	Black (BK)	2-10	156-01087
Q50REC5B		4.7	210.0	45.0	220	PA66W	PA66W	Black (BK)	2-10	156-01088

All dimensions in mm. Subject to technical changes.

2-Piece Fixing Ties for Edges, 1.0–3.0 mm, Top Fixing

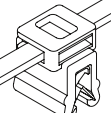
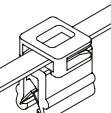
TYPE	Drawing	Width (W)	Length (L)	Bundle Ø max.		Material Cable Tie	Material Foot Part	Colour	Tools	Article-No.
Q50REC4A		4.7	210.0	45.0	220	PA66W	PA66W	Black (BK)	2-10	156-01085
Q50REC4B		4.7	210.0	45.0	220	PA66W	PA66W	Black (BK)	2-10	156-01086

All dimensions in mm. Subject to technical changes.

Recommended Tools									
2	3	4	5	6	7	8	9	10	
MK20	MK21	MK3SP	MK3PNSP2	EVO7	MK7HT	MK7P	MK6	MK9	

For detailed information on Application Tooling please refer to our Main Catalogue or the Internet.

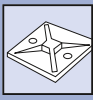

Cable Ties and Fixings

Cable Tie Mounts

Cable Tie Mounts Q-Series

Features and Benefits

- Screw or self adhesive versions
- Perfect for combination with Q-ties
- 4-way entry for Q-tie
- Adhesive with high pull-off force
- Q-Mount base secures the Q-tie in a vertical position, leaving the hands free to apply cables



Q-Mount QM, 4-way entry, self adhesive, screwable.

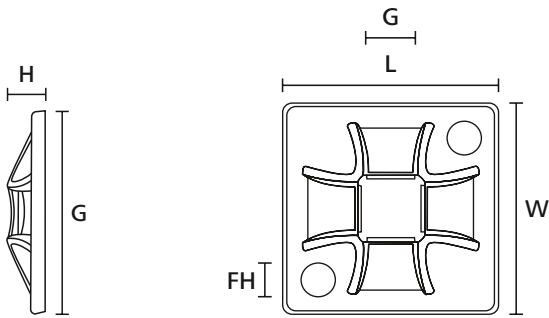

Q-Mount (side view)

Q-Mount (plan view)



The Q-mount base locks the Q-tie in vertical position, leaving the hands free to apply the cables.



Without additional effort only Q-ties can be used for temporary and final cable bundling.

Q-Mount Series QMA, self adhesive, screwable

TYPE	Width (W)	Length (L)	Height (H)	Hole Ø (FH)	Strap Width max. (G)	Material	Colour	Adhesive	Pack Cont.	Article-No.
QM20A	20.0	20.0	3.7	3,1	4.0	PA66	Black (BK)	Synthetic rubber T60	100 pcs.	151-10914
	20.0	20.0	3.7	3,1	4.0	PA66	Natural (NA)	Synthetic rubber T60	100 pcs.	151-10904
QM30A	30.0	30.0	4.5	4,1	5.1	PA66	Black (BK)	Synthetic rubber T60	100 pcs.	151-10915
	30.0	30.0	4.5	4,1	5.1	PA66	Natural (NA)	Synthetic rubber T60	100 pcs.	151-10905
QM40A	40.0	40.0	5.5	4,1	8.4	PA66	Black (BK)	Synthetic rubber T60	50 pcs.	151-10916
	40.0	40.0	5.5	4,1	8.4	PA66	Natural (NA)	Synthetic rubber T60	50 pcs.	151-10906

All dimensions in mm. Subject to technical changes.
Minimum Order Quantity (MOQ) may differ from package content. Other packaging options may also be available.

Q-Mount Series QM, screwable

TYPE	Width (W)	Length (L)	Height (H)	Hole Ø (FH)	Strap Width max. (G)	Material	Colour	Pack Cont.	Article-No.
QM20	20.0	20.0	3.7	3,1	4.0	PA66	Natural (NA)	100 pcs.	151-10901
	20.0	20.0	3.7	3,1	4.0	PA66	Black (BK)	100 pcs.	151-10911
QM30	30.0	30.0	4.5	4,1	5.1	PA66	Natural (NA)	100 pcs.	151-10902
	30.0	30.0	4.5	4,1	5.1	PA66	Black (BK)	100 pcs.	151-10912
QM40	40.0	40.0	5.5	4,1	8.4	PA66	Natural (NA)	50 pcs.	151-10903
	40.0	40.0	5.5	4,1	8.4	PA66	Black (BK)	50 pcs.	151-10913

All dimensions in mm. Subject to technical changes.
Minimum Order Quantity (MOQ) may differ from package content. Other packaging options may also be available.



Please note! Not all products listed on this page may have this approval.



Screw Fixing Cable Tie Mounts CTQM

Q-Mount Series CTQM

CTQM mounts are ideally suited for holding our innovative Q-ties in place. They would perfectly fit to all applications where a reliable and durable fixation is required and where space is limited.

Features and Benefits

- 2-way mounting base for safe guiding of cables and conduits
- For cable ties up to 5 mm wide
- Uses screw with countersunk head (max. \varnothing of head: 8.0 mm)
- Perfect for combination with Q-ties
- Pre-assembly feature
- Provides a secure hold with Q-ties, particularly in difficult situations such as vertical mounting positions



Q-Mount, CTQM 2-way entry, screwable.



Application video: Q-Series

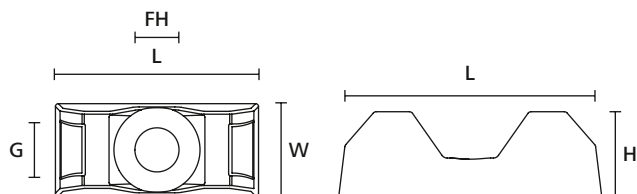

CTQM-Series (plan view)

CTQM-Series (side view)



Application tools
please see page 15.



Material specification
please see page 15.

TYPE	Width (W)	Length (L)	Height (H)	Hole \varnothing (FH)	Strap Width max. (G)	Material	Colour	Pack Cont.	Article-No.
CTQM5	9.5	21.0	6.7	4,5	5.0	PA66	Natural (NA)	100 pcs.	151-10920
	9.5	21.0	6.7	4,5	5.0	PA66	Black (BK)	100 pcs.	151-10930

All dimensions in mm. Subject to technical changes.

Minimum Order Quantity (MOQ) may differ from package content. Other packaging options may also be available.

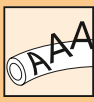

Identification tags for marking cable bundles

Q-tags

Features and Benefits

- Identify cable or cable bundle
- Quickly read or scan printed information
- Mark by hand with T82 series marker pen or use printed adhesive label
- HellermannTyton offers complete printing solution (printers, labels, ribbons)
- Perfect combination with Q-ties to safely secure and mark cables with highly visible text



The flagged orientation of Q-tags ensures that printed texts are easily visible.



Application video: Q-Series

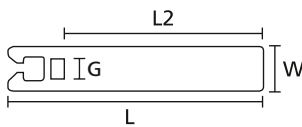

Q-tag QT7016R

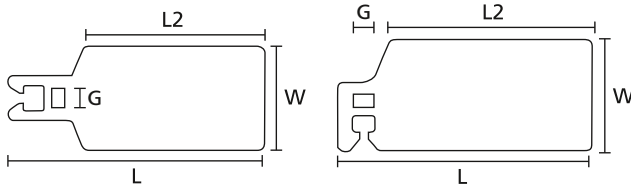

Q-tag QT7040R, QT10065R

Q-tag QT7040S



Q-tags can be labelled with pre-printed labels or by hand.



Q-tags are available in different sizes and types.

MATERIAL	Polyamide 6.6 (PA66)
Operating Temperature	-40 °C to +85 °C
Flammability	UL94 V2



TYPE	Length (L)	Length (L2)	Width (W)	Strap Width max. (G)	Pack Cont.	Colour	Article-No.
QT7040S	88.0	70.0	42.0	3.6	50 pcs.	White (WH)	151-10952
QT7016R	100.0	70.0	18.0	4.7	50 pcs.	White (WH)	151-10950
QT7040R	100.0	70.0	42.0	4.7	50 pcs.	White (WH)	151-10951
QT10065R	135.0	100.0	67.0	4.7	25 pcs.	White (WH)	151-10953

All dimensions in mm. Subject to technical changes.
Minimum Order Quantity (MOQ) may differ from package content.

TYPE	Description	Colour	Pack Cont.	Article-No.
T825-BK	Indelible Marker Pen	Black (BK)	2 pcs.	500-50820
T82R-RD	Indelible Marker Pen	Red (RD)	2 pcs.	500-50822

Subject to technical changes.
Minimum Order Quantity (MOQ) may differ from package content. Other packaging options may also be available.

Manual Processing Tools for Q-ties



MK20, MK21.

2, 3



MK35P.

4



EVO7/EVO75P.

6



MK7HT.

7



MK6.

9



MK9.

10



MK9HT.

11

Pneumatic Processing Tools for Q-ties



MK3PNSP2.

5



MK7P.

8



MK9P.

12

Material Specification Overview

MATERIAL	Material Shortcut	Operating Temperature	Colour**	Flammability	Material Properties*	Material Specifications
Polyamide 6.6	PA66	-40 °C to +85 °C, (+105 °C, 500 h)	Black (BK), Natural (NA)	UL94 V2	• High yield strength	HF RoHS
Polyamide 6.6, UV-resistant	PA66W	-40 °C to +85 °C, (+105 °C, 500 h)	Black (BK)	UL94 V2	• High yield strength • UV-resistant	HF RoHS
Polyamide 6.6, heat stabilised	PA66HS	-40 °C to +105 °C	Black (BK), Natural (NA)	UL94 V2	• High yield strength • Modified elevated max. temperature	HF RoHS

* These details are only rough guide values. They should not be regarded as a material specification and are no substitute for a suitability test. Please see our datasheets for further details.

**More colours on request.

HF = Halogenfree LFH = Limited Fire Hazard RoHS = Restriction of Hazardous Substances

= Minimum Loop Tensile Strength for Cable Ties (Newton)

Rubber Material Specifications

ADHESIVE		Adhesive Operating Temperature
Synthetic rubber with base of polyethylene foam	Synthetic rubber T50	-20 °C to +50 °C
	Synthetic rubber T60	-40 °C to +60 °C
Acrylate with base of polyurethane foam	Acrylate	to +105 °C
Acrylate with base of acrylic foam	mod. Acrylate	-40 °C to +90 °C

